

SECTION A-A

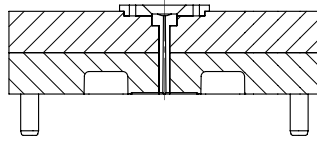

SECTION B-B

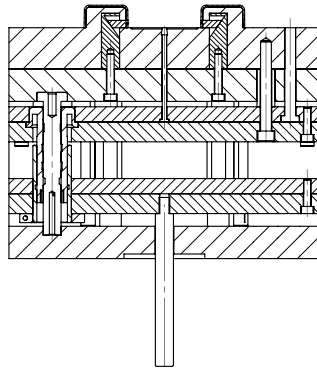

SECTION C-C

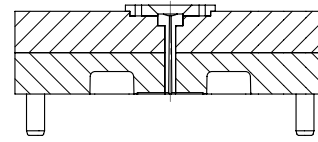

SECTION D-D

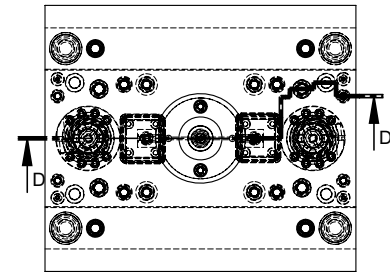
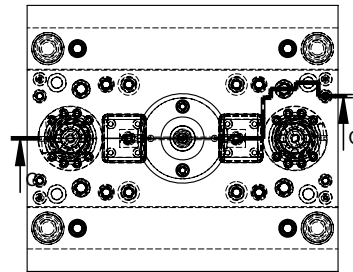
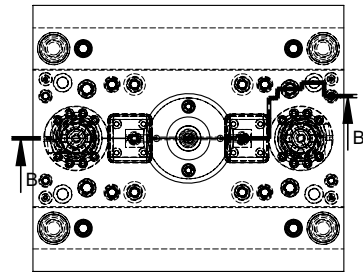
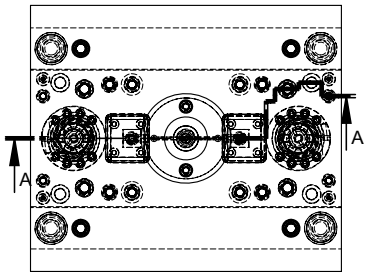
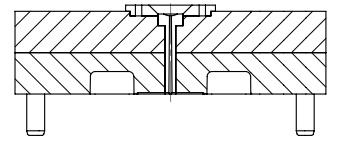

**TWO STAGE EJECTOR BOTTOM LAST - TSBL
APPLICATION EXAMPLE 3**