

Die Cast Chill Vents

Optimizing part quality
through efficient exhaustion

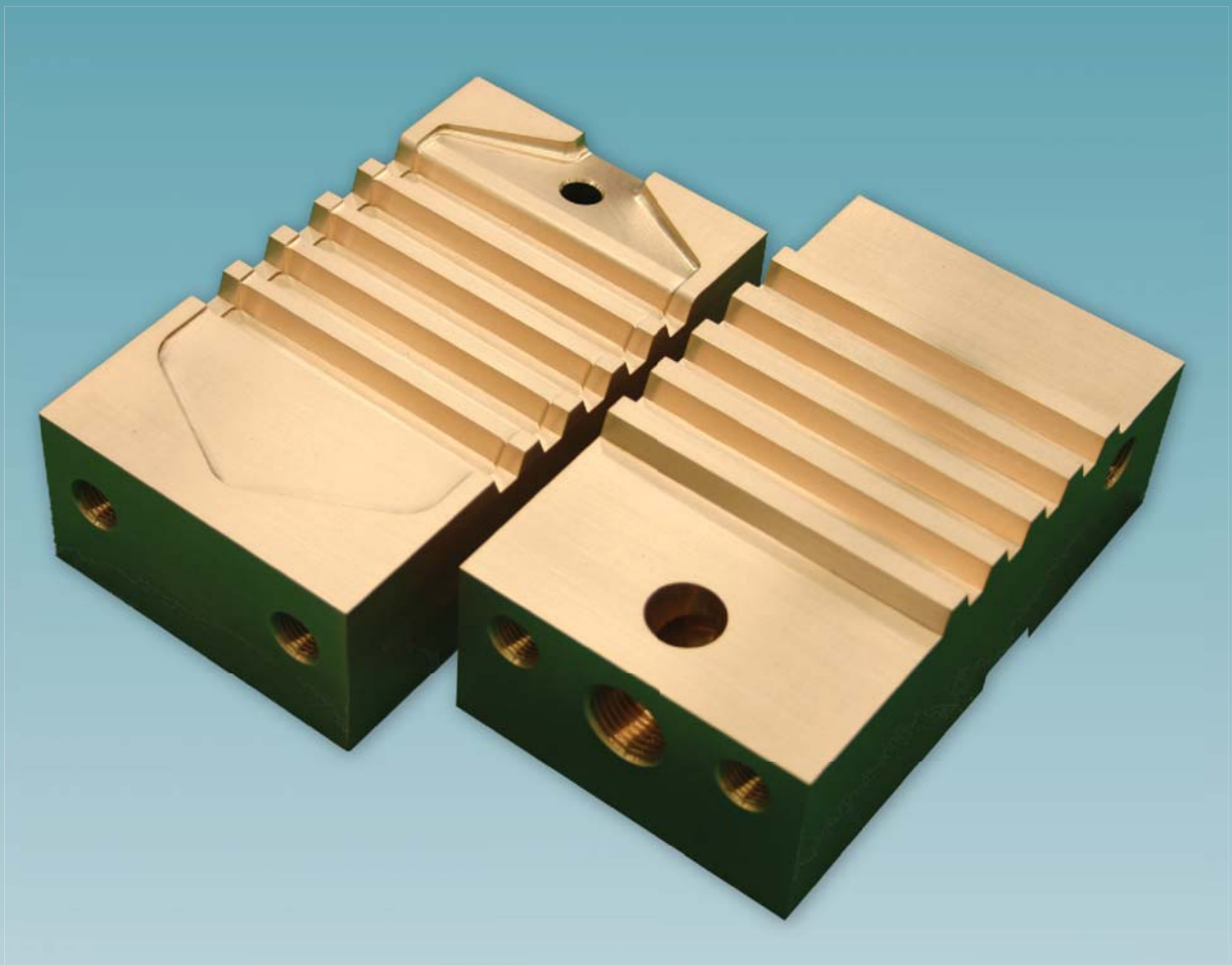

D-M-E Die Cast Chill Vents

Chill Vent Features & Benefits

- Chill vents are often used with permanent molds for die casting light metals such as aluminum and magnesium. The chill vent functions as a means of efficiently exhausting residual air and/or gas from the inside to the outside of a die cast mold cavity.
- Chill vents minimize the spouting of molten metal and reduce flashing when charging molten metal into the die cavity.
- If residual air and/or gas remains in the die cavity, the result may be gas holes in the castings that degrade product quality.
- Gas exhaust passage design is generally shaped in a zigzag manner to ensure that after the gas has been exhausted outside of the chill vent, the molten metal will be chilled in the zigzag passage before it is flashed outside of the permanent mold. However, since molten metal flows under high pressure, it is difficult to completely prevent flashing even by increasing the length of the chill vent.

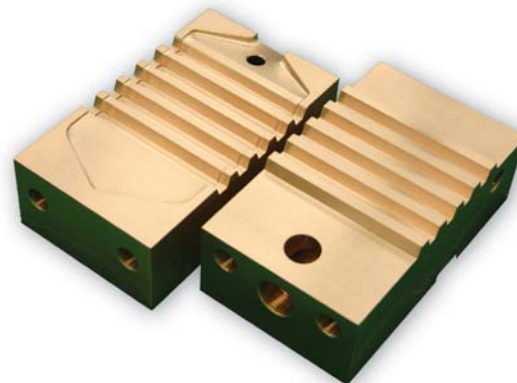

Why Chill Vents?

- Tool steels, although high in hardness, have low thermal conductivity, and, therefore, cannot rapidly remove heat from non-solidified molten metal before flashing occurs.
- Since both high hardness and superior thermal conductivity are critical requisites in achieving accelerated cooling of molten metal under high pressure, it has been considered that copper alloys would provide superior thermal conductivity. However, few copper alloys provide both thermal conductivity and hardness in combination sufficient to withstand the pressure that results in die casting molten metal.
- Additionally, copper alloys are generally difficult to use for molds brought into contact with molten metal because they are easily dissolved by light metal alloys compared to tool steel.
- Conventional chill vent material has been predominantly made of tool steel, typically the same as the permanent mold cavity. It is necessary that the chill vent be as hard as the permanent mold cavity due to the high-pressure condition that develops when the molten metal is charged into the chill vent.

Why Beryllium Copper?

- Only one alloy, beryllium copper, can provide both the hardness and thermal conductive properties required for use as a chill vent in aluminum and/or magnesium die casting.
- Beryllium copper also provides the benefit of causing a passive-state oxide film to be formed on the surface of the chill vent, thereby preventing dissolution by light metal alloys.
- These factors provide an effective means of exhausting air and gases outside the mold without being dissolved while chilling the molten metal before flashing occurs.
- As a further consideration, the addition of water cooling pipes in the chill vent will serve to improve the overall cooling power which can result in a shortening of the length of the gas exhaust passage, leading to a smaller chill vent, thus increasing die space.

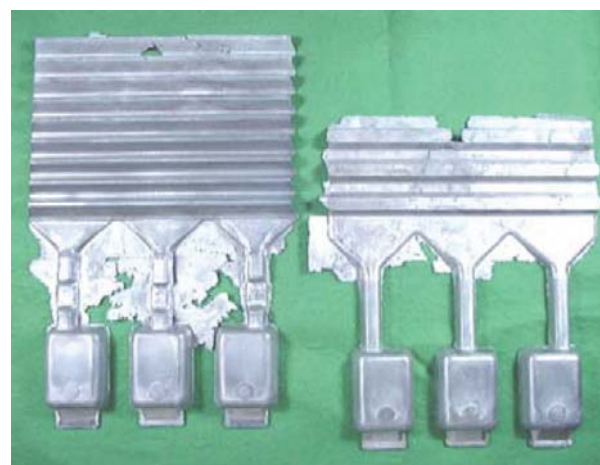

D-M-E Die Cast Chill Vents

Reduces Porosity

- *Large vent gap promotes better venting*
(**3-8 times** better than conventional H13)
- *Longer effective vacuum time* since the metal always freezes in the vent
(Avoids the time lag caused by the vacuum valve)

Cuts Downtime & Maintenance Costs with Vacuum Machine

D-M-E Chill Vents can be used with a vacuum machine *in place of the vacuum valve*, reducing maintenance cost, downtime and porosity.

- Protects vacuum system from molten aluminum
 - Vacuum valve can be replaced with a D-M-E chill vent
 - High solidification rate prevents aluminum from entering the vacuum equipment
- Easy to use
 - Its *simple structure* requires no special knowledge or technique

Minimizes Sticking

- *Copper doesn't promote a chemical reaction* with aluminum compared with H13
- The *thicker waffle* from the large vent gap is easily removed, and is higher quality scrap
- *Low surface temperature* due to high conductivity further avoids sticking

Saves Die Space

The size of vent area can be *half* that needed for H13 due to higher solidification performance. This reduce the total die area.

Why D-M-E Chill Vents?

1) Made of Hard Copper Alloy (*Beryllium Copper*)

- No reaction with aluminum → **No "Sticking"**
- *H13 reacts with aluminum → Causes "Sticking"

2) High Thermal Conductivity

* Beryllium copper is seven times more conductive than H13 for faster chilling and faster solidification of the molten alloy.

* Allows a larger vent gap (1.4 to 1.8 times larger than H13) for better gas exhaustibility (3 to 8 times more than H13) to reduce porosity!

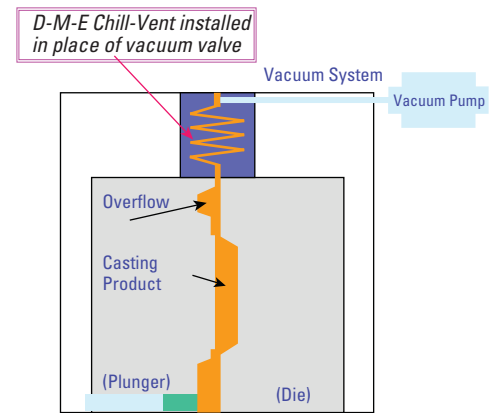
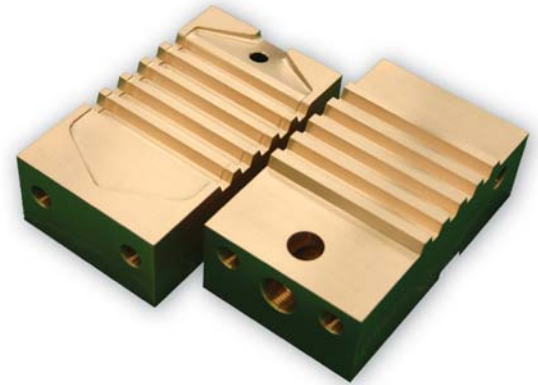
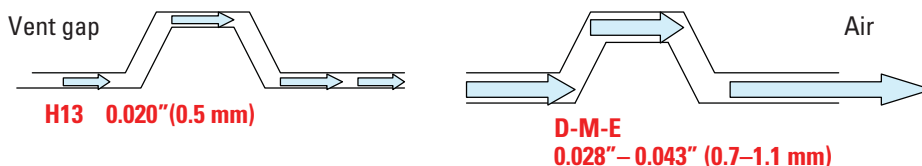

Compatible with Vacuum Machine

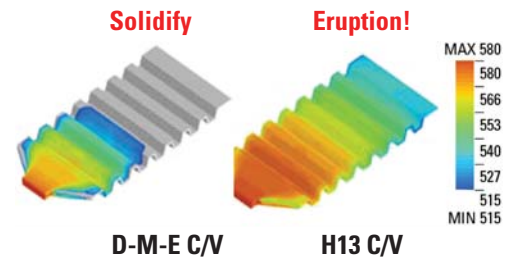

Product Availability

- Copper Alloy (Beryllium Copper) supplied by NGK Beryl Co./ NGK Metals Corp.
- All copper alloy recommended for A390, zinc and all alloys
- Vacuum/non-vacuum type
- Custom designs are welcome

D-M-E Die Cast Chill Vents

IMPORTANT SAFETY INFORMATION



BEFORE USING THIS PRODUCT, REFER TO IMPORTANT SAFETY INFORMATION AT MANUFACTURER'S WEBSITE:

<http://www.ngkmetals.com/index.cfm/m/19>

ADDITIONAL INFORMATION MAY BE FOUND AT:

http://www.osha.gov/dts/hib/hib_data/hib19990902.html

READ ALL INSTRUCTIONS BEFORE HANDLING THIS PRODUCT INCLUDING THE MSDS.

THIS INSTRUCTION IS TO BE PROVIDED TO THE END USER.

INSTALLATION INSTRUCTIONS

POCKET DIMENSIONS			
ITEM NUMBER	"Xp" + 0.030 / + 0.010 (+ 0.0012 / + 0.0004")	"Yp" + 0.030 / + 0.010 (+ 0.0012 / + 0.0004")	"Zp"
VSCL7US	135.000 (5.3150")	80.000 (3.1496")	SEE POCKET NOTES
VLCL7US	175.000 (6.8998")	90.000 (3.5433")	
VECL7US	185.000 (7.2835")	100.000 (3.9370")	

Dimensions shown are in millimeters (inches).

POCKET NOTES:

- Perpendicularity and parallelism of pockets must be machined such that Chill Vent insert halves mate after installation without gaps between insert halves.
- Corner radii of Chill Vent insert pockets are to be machined to suit dimensions shown.
- All surfaces of pocket to have a surface finish no greater than 0.8 μm (micrometers). Check for burrs.
- For Zp, use shim pack to accommodate flushness. Flushness tolerance must be + 0.05/- 0 (+ 0.002/- 0"). Zp must be greater than Z (applies to both insert halves and pockets).

CHILL VENT DIMENSIONS												
ITEM NUMBER	"X" + 0 / - 0.06 (+ 0 / - 0.003")	"Y" + 0 / - 0.05 (+ 0 / - 0.02")	"Z" + 0.05 / - 0 (+ 0.002 / - 0")	\emptyset D1 + 0.02 / - 0 (+ 0.00 / - 0")	"P"	"K" +/- 0.046 (+/- 0.0018")	"B"	SCREW THREAD	"L1"	"F1" × THREAD DEPTH	\emptyset D2	"T"
VSCL7US	135.00 (5.315")	80.00 (3.150")	50.00 (1.968")	10.00 (0.394")	26.0 (1.02")	55.00 (2.165")	40.0 (1.575")	5/16 - 18 UNC	20.00 (0.787")	1/2 - 14 NPT × 10.0 (0.39)	18.00 (0.709")	45.00 (1.772")
VLCL7US	175.00 (6.890")	90.00 (3.543")	50.00 (1.968")	10.00 (0.394")	30.0 (0.18")	65.00 (2.559")	60.0 (2.36")	1/2 - 13 UNC	25.00 (0.984")	3/4 - 14 NPT × 12.0 (0.47)	23.00 (0.906")	45.00 (1.772")
VECL7US	185.00 (7.283")	100.00 (3.937")	50.00 (1.968")	10.00 (0.394")	35.0 (1.38")	65.00 (2.559")	60.0 (2.36")	1/2 - 13 UNC	25.00 (0.984")	3/4 - 14 NPT × 12.0 (0.47)	23.00 (0.906")	50.00 (1.968")

CHILL VENT POCKET DETAIL

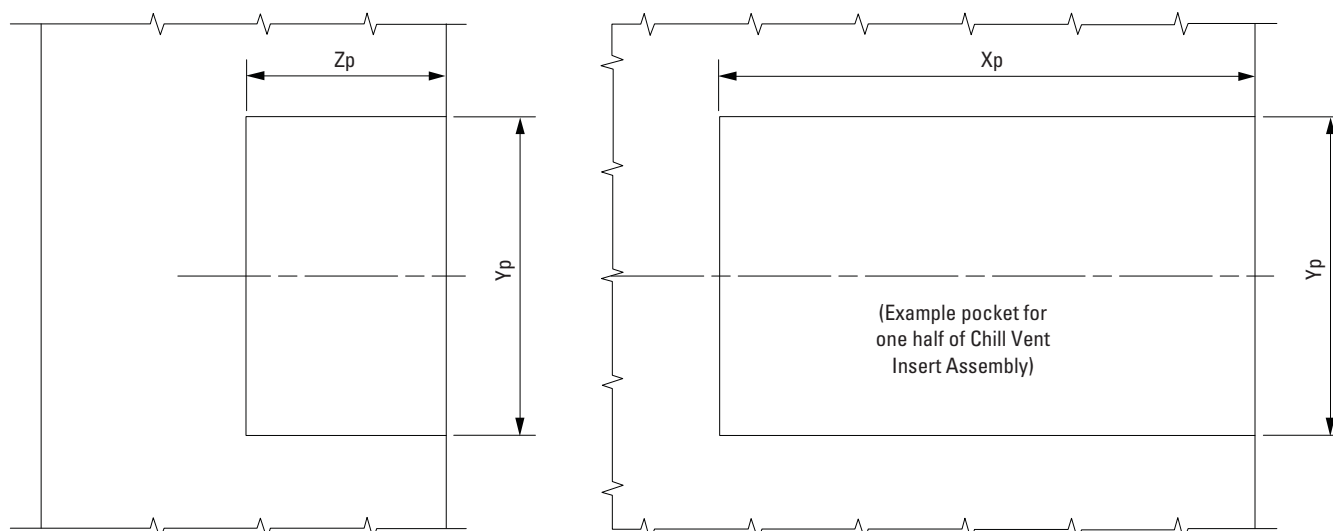

D-M-E Die Cast Chill Vents

CHILL VENT INSERT – DETAIL

TOP HALF

NOTE: Dimensions shown are in millimeters (inches).

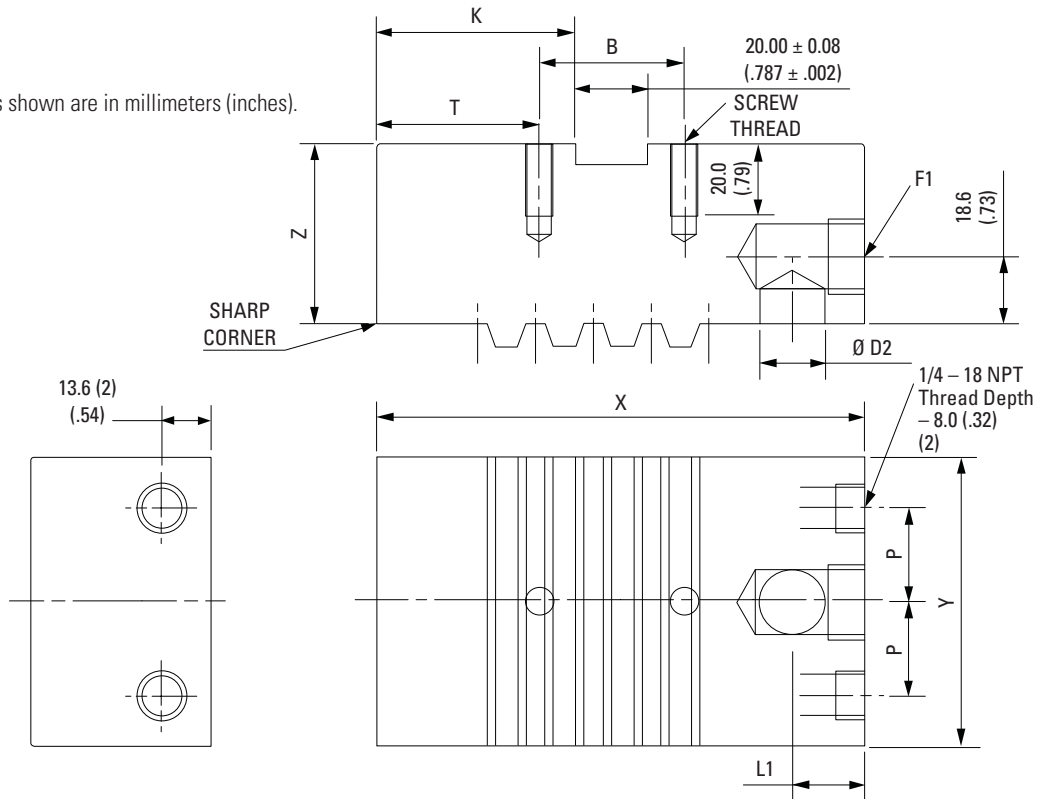

INSTALLATION NOTES:

- 10mm DIN Ejector Pin to be used with this product
- Key slots provided on product as shown. Customer is responsible for keying product.
- Tap threads are provided in product for retaining screws. Customer to supply screws.
- Customer to supply NPT pipe fittings. High temperature pipe thread sealant is recommended to be used with this product.
- Once installed, Chill Vent insert halves must align properly to achieve good seal-off between mating surfaces. Use a blue-off compound to check for proper fit. Adjust shim pack accordingly during installation until desired mating seal-off is achieved.

NOTICE:

D-M-E shall not be liable for misuse or failure to follow the enclosed instructions and specifications. D-M-E hereby disclaims all implied warranties, including merchantability and fitness for a particular purpose. In no event shall D-M-E be responsible for loss of use, revenue or profit, or for incidental or consequential damages.

BOTTOM HALF

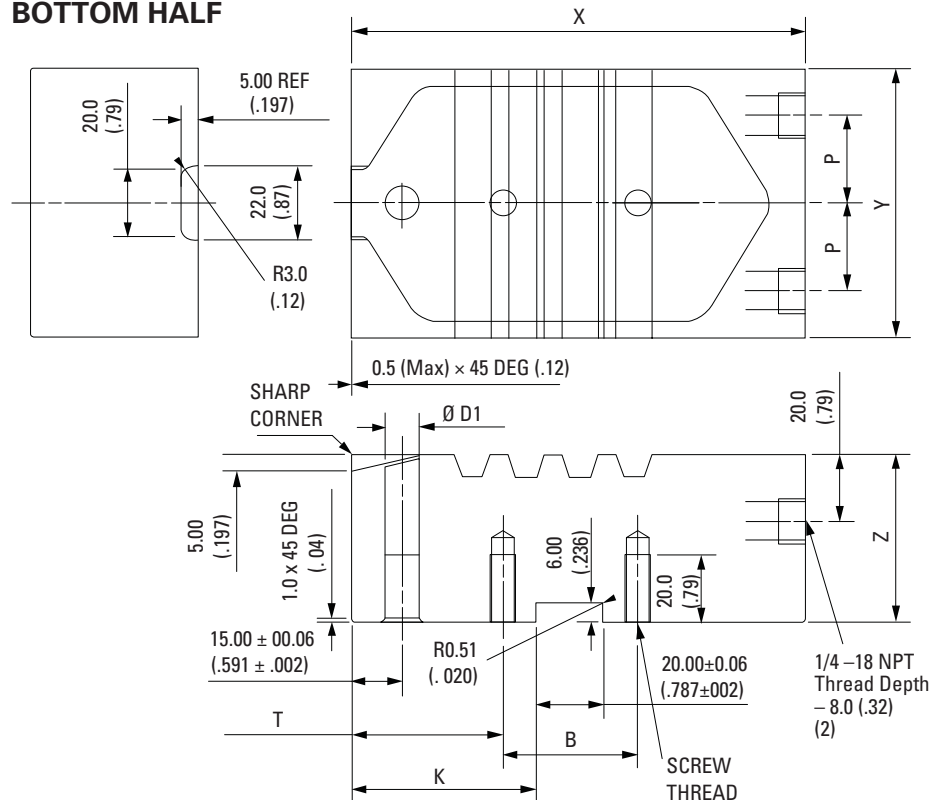

D-M-E, an essential resource to the customers it serves worldwide, offers the industry's broadest range of market-leading products, unsurpassed knowledge and expertise, a global logistics infrastructure that ensures speed and accuracy, and a support organization unrivaled for its ability to assist customers when and where they need it. A complete line of unit dies, die components, hot runner systems, control systems, mold bases, MUD quick-change mold systems, mold components, moldmaking and molding supplies, cold runner systems for elastomers, and technical services helps customers compete every step of the way.



See the complete line of D-M-E die cast die assemblies, unit dies and components at www.dme.net/dme/resources/catalog.html or D-M-E call Customer Service to request a printed catalog.



World Headquarters

D-M-E Company

29111 Stephenson Highway
Madison Heights, MI 48071
800-626-6653 toll-free tel
248-398-6000 tel
888-808-4363 toll-free fax
www.dme.net web
sales@dme.net e-mail

D-M-E of Canada, Ltd.

6210 Northwest Drive
Mississauga, Ontario
Canada L4V 1J6
800-387-6600 toll-free tel
905-677-6370 tel
800-461-9965 toll-free fax
dme_canada@dme.net e-mail

D-M-E Europe

D-M-E Belgium C.V.B.A.
Industriepark Noord
B-2800 Mechelen
Belgium
32-15-215011 tel
32-15-218235 fax
sales@dmeeu.com e-mail